

3/2 ExpoEis

- PER RADDOPPIARE LA CAPACITÀ DI GELATO, LE VASCHETTE NON DEVONO SUPERARE h = mm.120.
- IN ORDER TO DOUBLE THE CAPACITY TO HOLD ICE-CREAM, THE HEIGHT OF THE BASINS MUST NOT EXCEED h = 120 mm.

- LE VASCHETTE E I LAVAPORZIONATORI VENGONO FORNITI A RICHIESTA.
- BASINS AND ICE-CREAM WASH DOSINGS ARE AVAILABLE ON REQUEST.

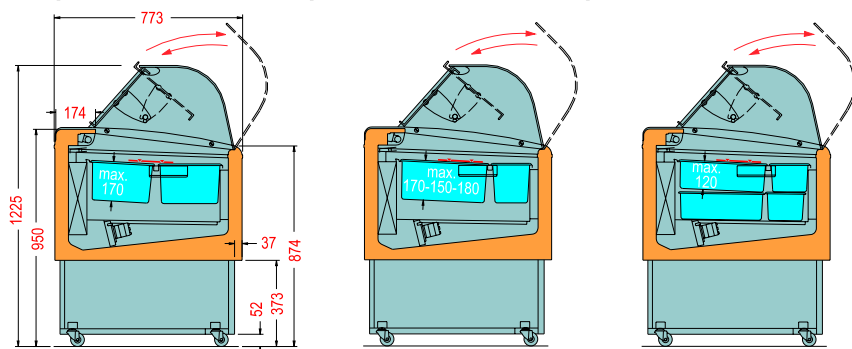

Carisma



Carisma 6+6



Carisma 7+7

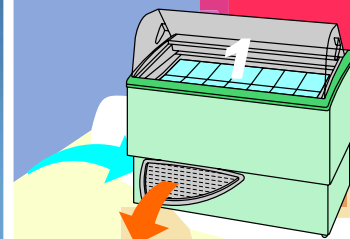

W= lt.4,5 h.170

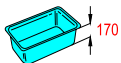

X= lt.5 h.120

Z= lt.7 h.150

T= lt.9 h.180

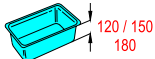

X= lt.5 h.120

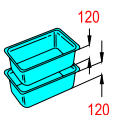

Carisma 4+4



Cod. 09



Cod. 39



Dati di collaudo
Test details
MAX = (30°C - % U.R. 55)

W (Carisma 4+4)

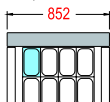

X/Z/T (Carisma 4+4)

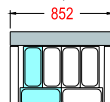

W (Carisma 6+6)

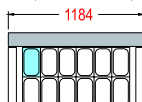

X/Z/T (Carisma 6+6)

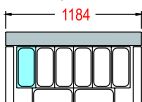

W (Carisma 7+7)

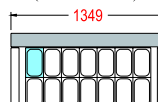

X/Z/T (Carisma 7+7)

